

PERSIANAS ALICANTINAS

GUÍA DE INSTALACIÓN

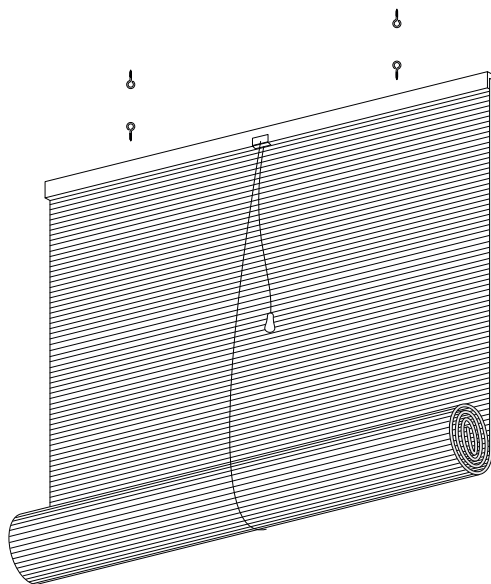

Comprobamos las piezas

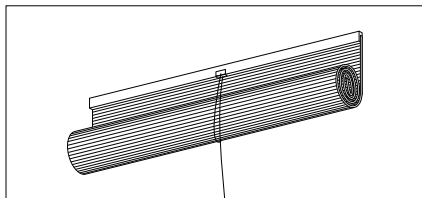

Persiana alicantina

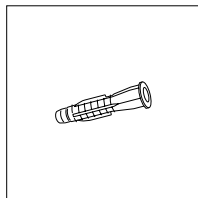

Tacos*

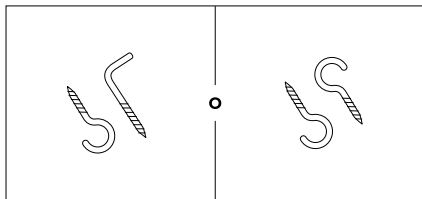

Ganchos*
para pared

Ganchos*
para techo

**Si la instalación se va a realizar en alguna superficie que no sea ladrillo, es recomendable adquirir alguna tornillería específica.*

Necesitamos

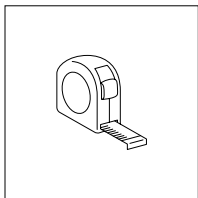

Cinta métrica

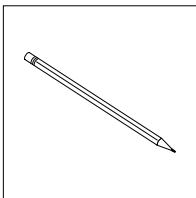

Lápiz

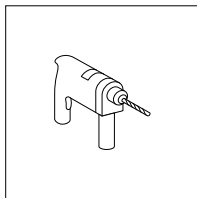

Taladro

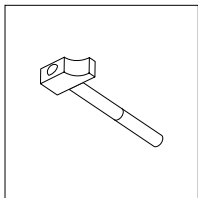

Martillo

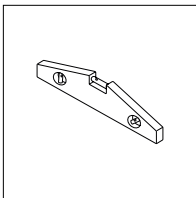

Nivel

1 | Preparamos la alicantina

INSTALACIÓN A PARED

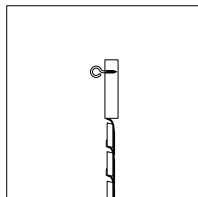
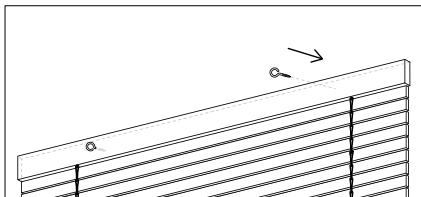

Fijar

INSTALACIÓN A TECHO

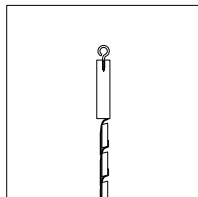
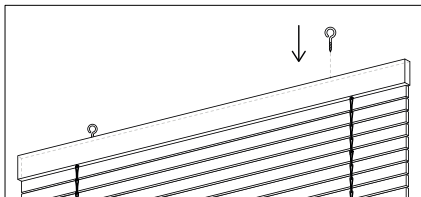

Fijar

Fijamos las hembrillas en la alicantina.

2 | Ubicamos las hembrillas

INSTALACIÓN A PARED

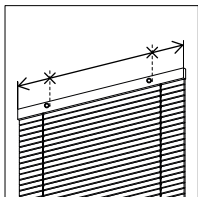

Medir

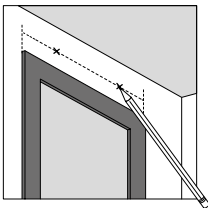

Medir y marcar

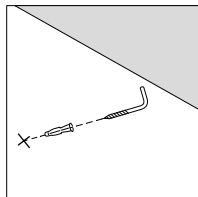

Fijar

INSTALACIÓN A TECHO

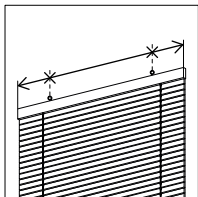

Medir

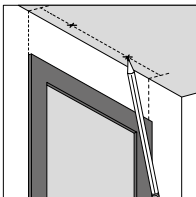

Medir y marcar

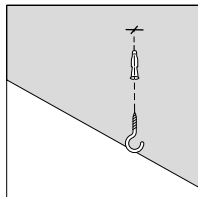

Fijar

Con el metro, **medimos** la alicantina y **ubicamos** las hembrillas que **acabamos** de instalar. **Trasladamos** las medidas a la pared y **marcamos** con un lápiz la ubicación de las hembrillas. **Taladramos**, **colocamos** los tacos y **fijamos** los tornillos.

3| Colocamos la alicantina

INSTALACIÓN A PARED

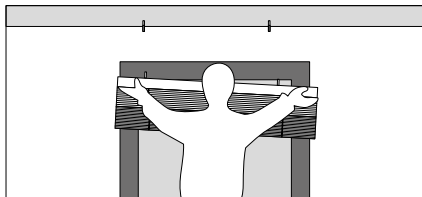

Introducir

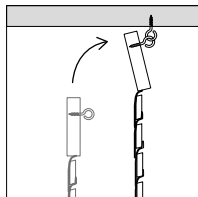

INSTALACIÓN A TECHO

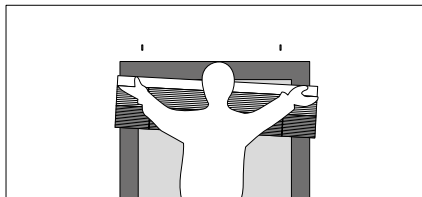

Introducir

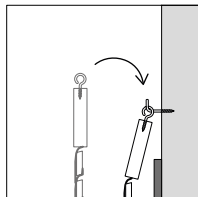

Introducimos las hembrillas fijado a la alicantina en los tornillos fijados en la pared o en el techo.

Atención al cliente

soporte@cortinadecor.com

966 181 033

www.cortinadecor.com