

**CORTINAS PLISADAS TÉRMICAS**  
**PERFECT FIT**  
GUÍA DE INSTALACIÓN

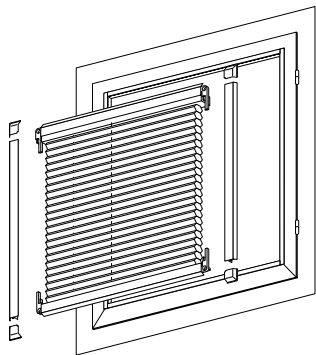

1.

## CORTINAS PLISADAS TÉRMICAS PERFECT FIT

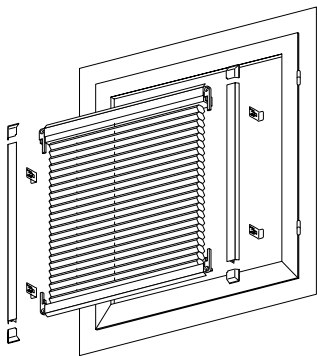
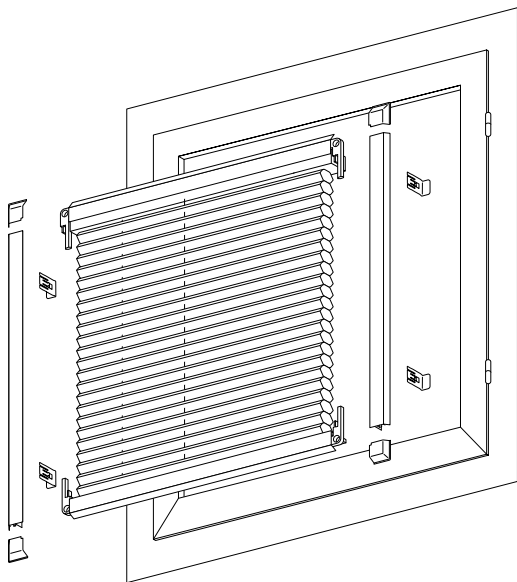

# Comprobar piezas

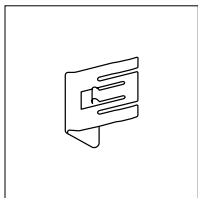

**Soportes**

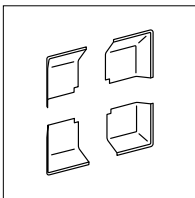

**Embellecedores**

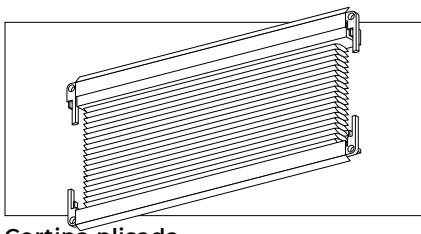

**Cortina plisada**

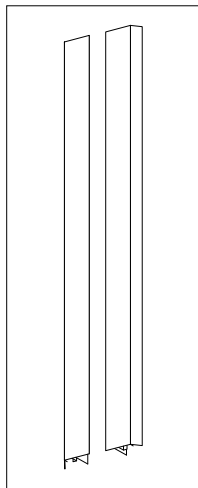

**Guías laterales**

# Necesitamos

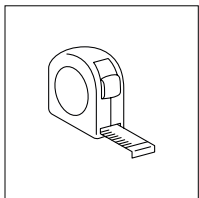

**Cinta métrica**

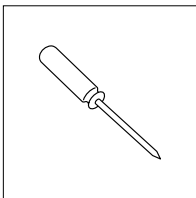

**Destornillador**

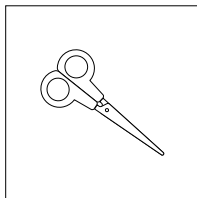

**Tijeras**

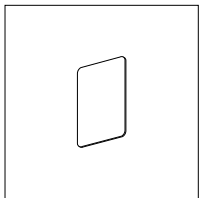

**Tarjeta  
de crédito**

# 1| Preparamos las cuerdas

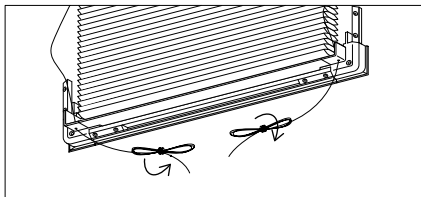

Soltar

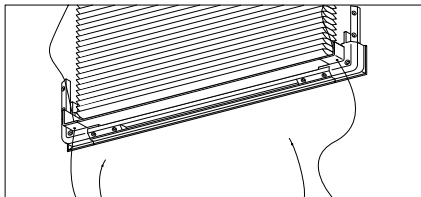

---

**Soltamos** las lazadas de las cuerdas de la parte trasera.  
**Importante no desatar el nudo de tope final.**

## 2 | Unimos las guías laterales

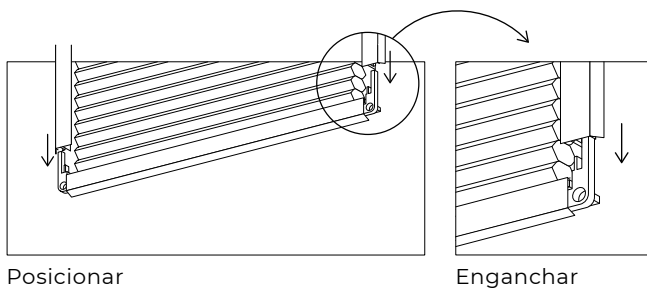
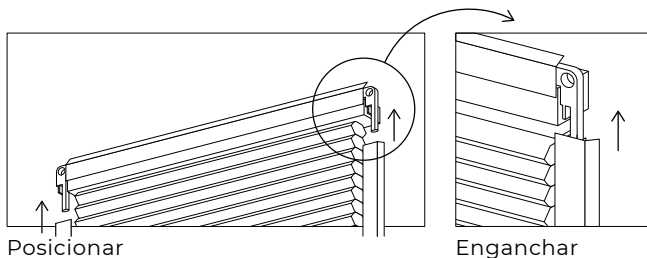

---

**Posicionamos** las guías a cada lado de la cortina  
y **las enganhamos** al perfil superior y al perfil inferior.

### 3| Colocamos los embellecedores

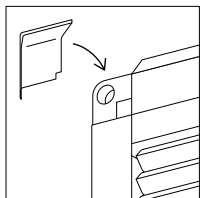

Colocar

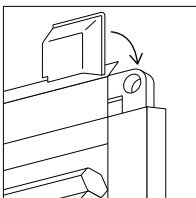

Colocar

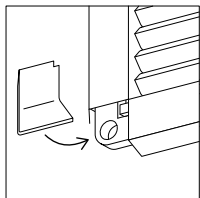

Colocar

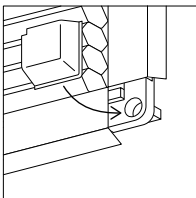

Colocar

## 4 | Fijamos las esquinas

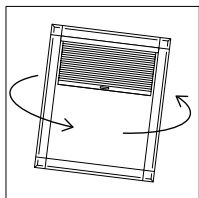

Girar

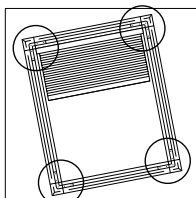

Visualizar

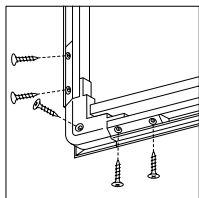

Fijar

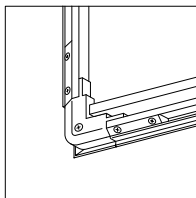

---

**Giramos** el marco y, en la parte trasera, **visualizamos** los agujeros que están en cada esquina. **Fijamos** los tornillos en los agujeros y **repetimos** la operación en cada esquina del marco.



## 5 | Enganchamos los soportes

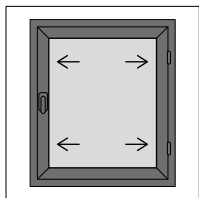

Ubicar

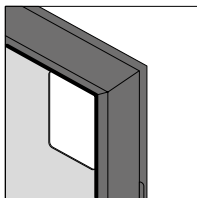

Posicionar

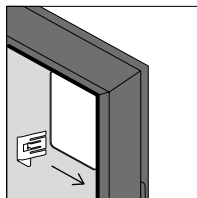

Colocar

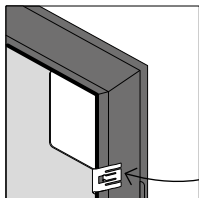

Ajustar

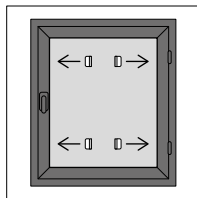
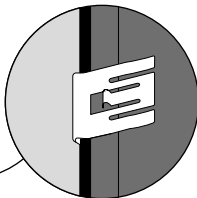

Colocar

---

Los soportes se colocan dentro de la junta de silicona del marco de la ventana. **Los colocamos** en los laterales con ayuda de la tarjeta para **ubicarlos** a una distancia correcta de la esquina.

## 6 | Colocamos la cortina plisada

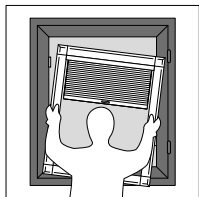

Posicionar

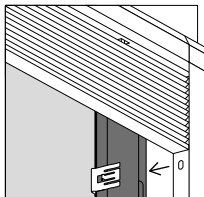

Colocar

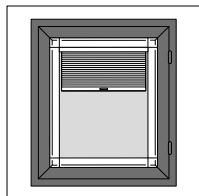
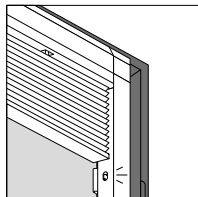

---

**Posicionamos** la cortina plisada en frente de los soportes y **la enganchamos** hasta que haga « clic » en todos los soportes.

2.

## CORTINAS PLISADAS TÉRMICAS PERFECT FIT CON IMÁN

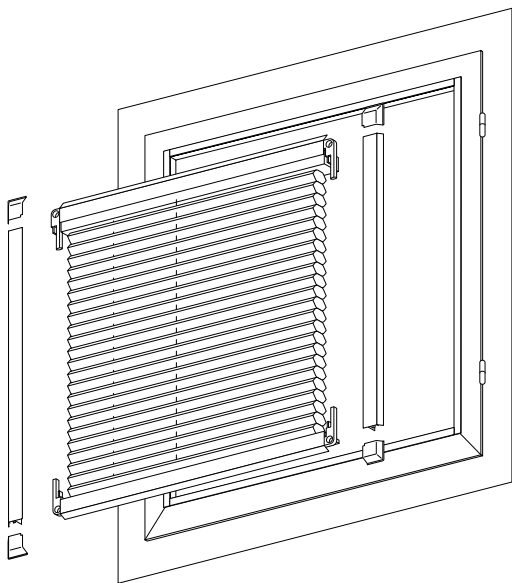

# Comprobar piezas

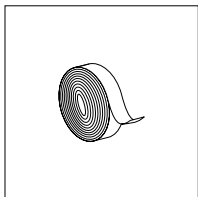

**Cinta magnética**

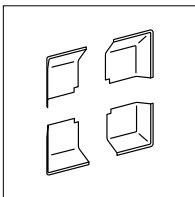

**Embellecedores**

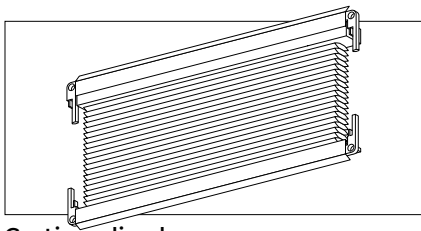

**Cortina plisada**

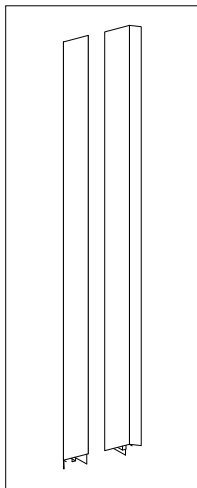

**Guías laterales**

## Necesitamos

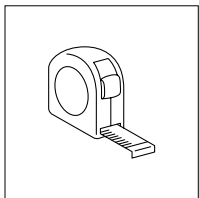

**Cinta métrica**

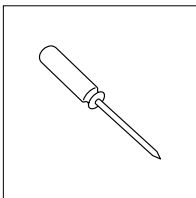

**Destornillador**

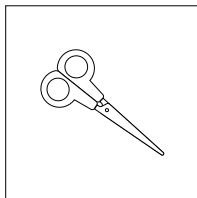

**Tijeras**

## 1| Preparamos las cuerdas

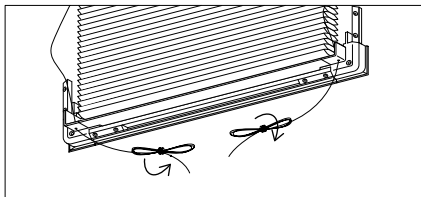

Soltar

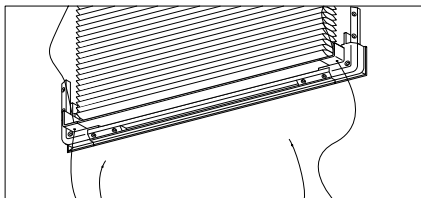

---

**Soltamos** las lazadas de las cuerdas de la parte trasera.  
**Importante no desatar el nudo de tope final.**

## 2 | Unimos las guías laterales

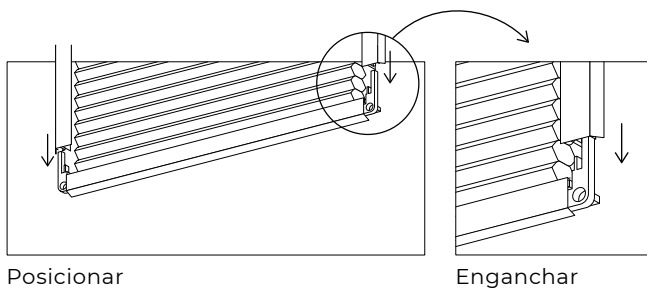
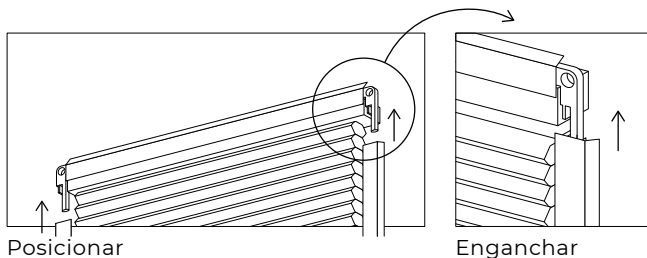

---

**Posicionamos** las guías a cada lado de la cortina  
y **las enganhamos** al perfil superior y al perfil inferior.

### 3| Colocamos los embellecedores

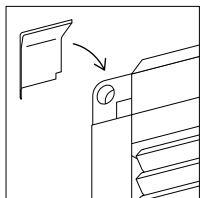

Colocar

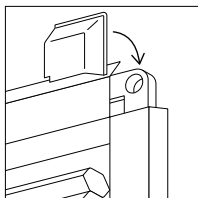

Colocar

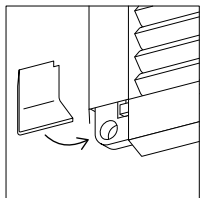

Colocar

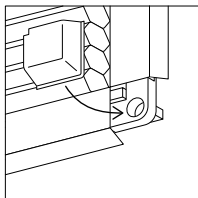

Colocar



## 4 | Fijamos las esquinas

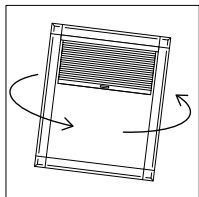

Girar

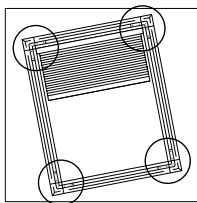

Visualizar

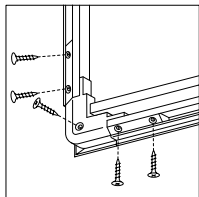

Fijar

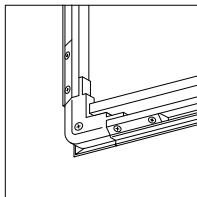

---

**Giramos** el marco y en la parte trasera **visualizamos** los agujeros que están en cada esquina. **Fijamos** los tornillos en los agujeros y **repetimos** la operación en cada esquina del marco.

## 5 | Preparamos la cinta magnética

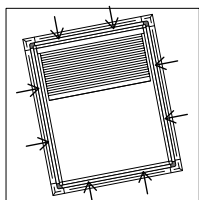

Visualizar

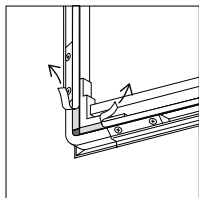
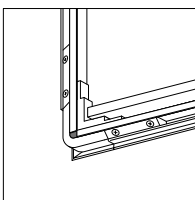

Quitar

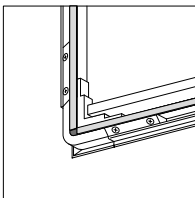

---

**Visualizamos** el sitio donde hay la cinta magnética y **quitamos** el papel protector de la cinta.

## 6 | Pegamos la cortina plisada

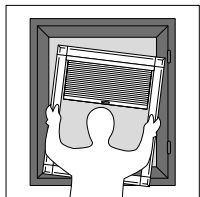

Posicionar

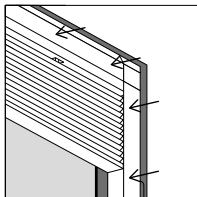

Presionar

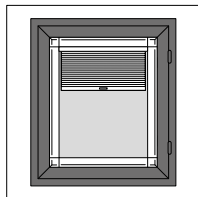

Quitar

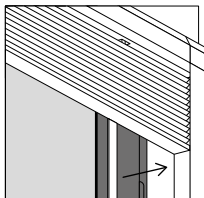

Quitar

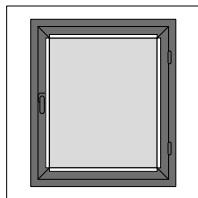

Verificar

---

**Posicionamos** la cortina plisada en frente de la cinta magnética y **la colocamos. Aplicamos** un presión sobre el marco de la plisada para que la cinta magnética se pegue al marco de la ventana. **Retiramos** la plisada y **verificamos** que la cinta está firmemente adherida.

**Atención al cliente**

[soporte@cortinadecor.com](mailto:soporte@cortinadecor.com)

966 181 033

[www.cortinadecor.com](http://www.cortinadecor.com)